

Angular Contact Ball Bearings

Bearing No. : **NACHI 7309DF**

■ Bearing Type

■ Clearance

■ Tolerance Class

Dimensions

d = 45 ⁰_{-0.012}
 D = 100 ⁰_{-0.015}
 B = 25 ⁰_{0.000}
 r = 1.5~2.3
 (Radial Direction)
 r = 1.5~4
 (Axial Direction)
 r1 = 1~1.5
 (Radial Direction)
 r1 = 1~3
 (Axial Direction)
 a = 8.4

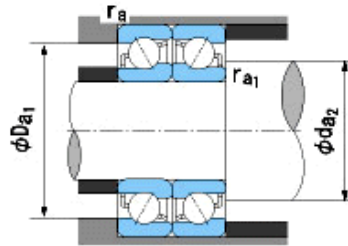
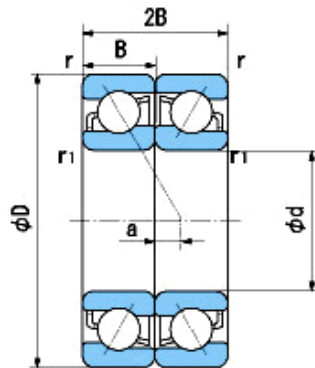

Dimensions

da1(min) = 54
 da2(min) = 50
 Da1(max) = 91
 Da2(max) = 94.6
 ra(max) = 1.5
 ra1(max) = 1
 Mass = 1.75 kg

Basic Dynamic Load Rating Cr : **103,000** N
 Basic Static Load Rating Cor : **87,000** N
 Limiting Speed ;
 Grease Lubrication : **5,000** min⁻¹
 Oil Lubrication : **6,700** min⁻¹

	INNER RING	OUTER RING
O.D.Surface Runout with Side :		-
Axial Runout with Bore :	-	-
Axial Runout with Raceway :	-	-
Width Variation :	0.020	0.020
Radial Runout :	0.015	0.035